

0701-0097

1999-10 Chevy/GMC 1500/2500LD Regular Cab
2001-10 Chevy/GMC 2500HD/3500 Regular Cab

Components List:

- 2 – Stainless steel oval step bars
- 2 – Front Bracket – Driver & Passenger Side
- 2 – Rear Bracket – Driver & Passenger Side
- 2 – Front Support Brace – Driver & Passenger Side
- 2 – Rear Support Brace
- 2 – Nut Plate

Parts List:

- 2 – M12-1.25 x 50mm Hex Head Bolts
- 4 – M12 Flat Washers
- 2 – M12 Lock Washers
- 2 – M12 Hex Nut
- 6 – M10-1.75 x 30mm Hex Bolt
- 10 – M10 Flat Washer
- 6 – M10 Lock Washers
- 4 – M10 Hex Nut
- 8 – M10 button head bolt
- 8 – M10 lock washers
- 8 – M10 Flat washers

Installation Instruction:

1. Verify all the parts from the list above are present and accounted for. Please read instructions completely before starting.
2. Remove existing body mount bolts as shown. **DO NOT DISCARD! (Fig. 1)**
3. Install front and rear brackets as shown (**Fig. 1 & 2**). Hand tighten.
4. Slide front nut plate into slot on the underside of vehicle frame (behind front body mount). Nut to be positioned over hole (**Fig. 2**)
5. Install front and rear support braces as shown. Hand tighten. **Note:** For rear brace, slide rear strap between main bracket and frame (**Fig. 1**). For front brace, use correct brace for Light Duty or Heavy Duty (**Fig. 2 & 3**)
6. Place oval step bars on brackets. Each step bar is marked driver and passenger.

7. Assemble with M10 button head bolts and M10 washers. 2 bolts per bracket, 4 bolts per bar (see Fig 4). Hand tighten.

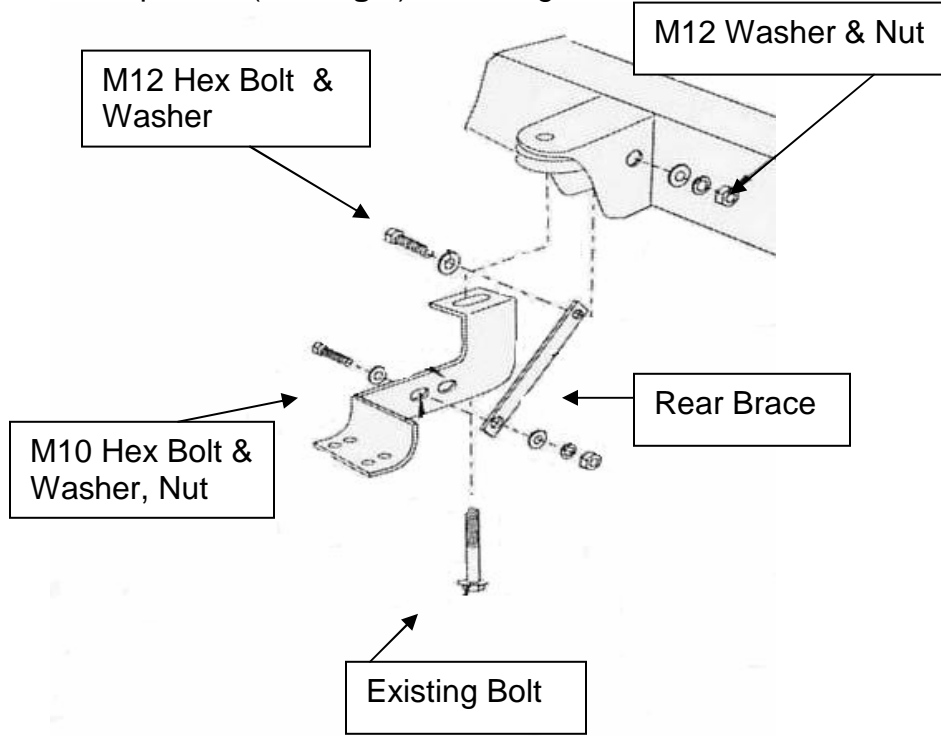

Figure 1. Passenger Side Rear Bracket Shown

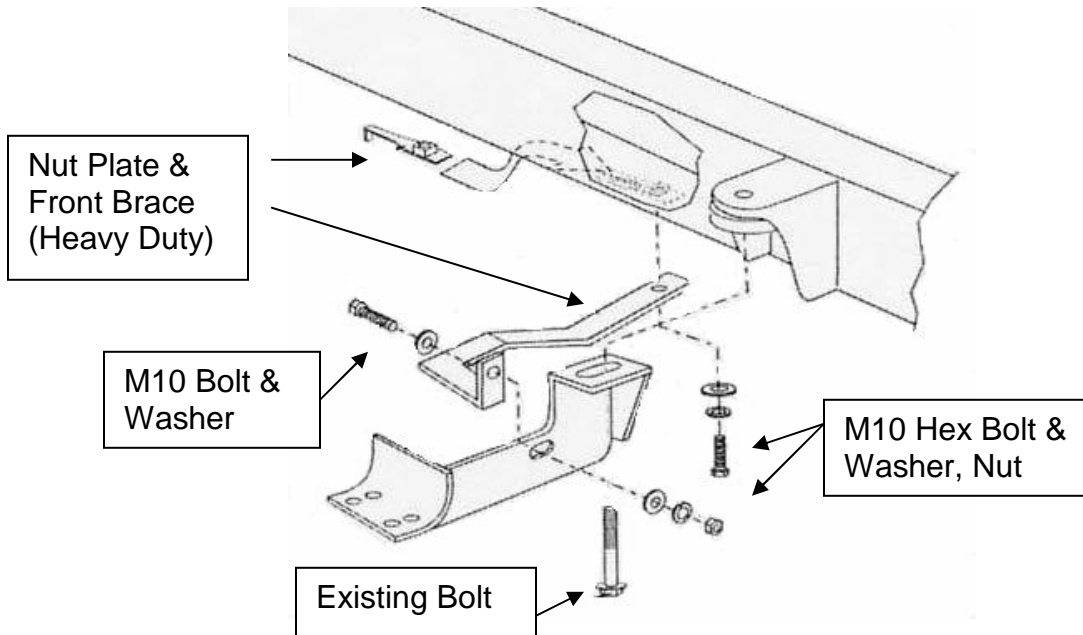

Figure 2. Passenger Side Front Bracket Shown

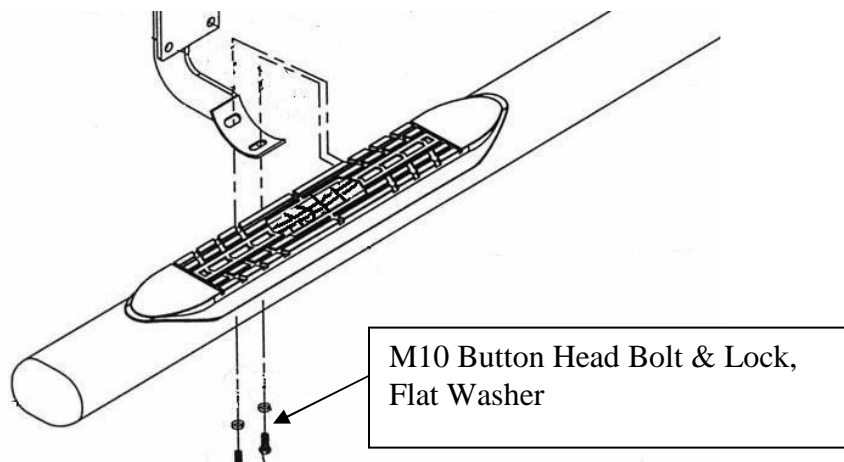
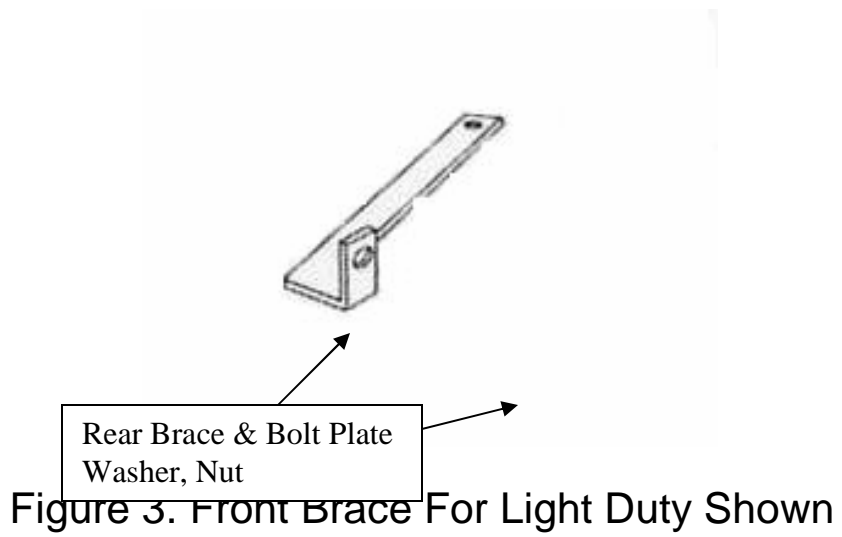

Figure 4. Installation View of Bracket & Bar