

0704-0270

2005-10 Toyota Tacoma Double Cab (S/B & L/B)

Components List:

- 2 – Stainless steel oval step bars
- 1 – Front Bracket-Driver Side
- 1 – Front Bracket-Passenger Side
- 2 – Center & Rear Bracket-Drivers Side
- 2 – Center & Rear Bracket-Passenger Side

Parts List:

- 12 – M8-1.25 x 30 mm hex head bolts
- 12 – M8 flat washers
- 12 – M8 lock washers
- 12 – M10 button head bolt
- 12 – M10 lock washers
- 12 – M10 flat washers

Installation Instruction:

1. Remove contents from box and check for damage. Verify all the parts from the list above are present and accounted for. Please read instructions completely before starting.
2. Install passenger front bracket as shown using two M8-1.25 x 30mm hex head bolts, M8 flat washers, and M8 lock washers by attaching to underside of body panel. Hand tighten. Use existing factory hole in body panel for install (**see Fig 1**).
3. Install center and rear passenger brackets by repeating step 2. Hand tighten. (**see Fig. 2**)
4. Place passenger side step bar on brackets. Each step bar is marked driver and passenger.
5. Assemble with M10 button head bolts and M10 washers. 2 bolts per bracket, 6 bolts per bar (**see Fig 3**). Hand tighten.
6. Repeat installation for driver side.

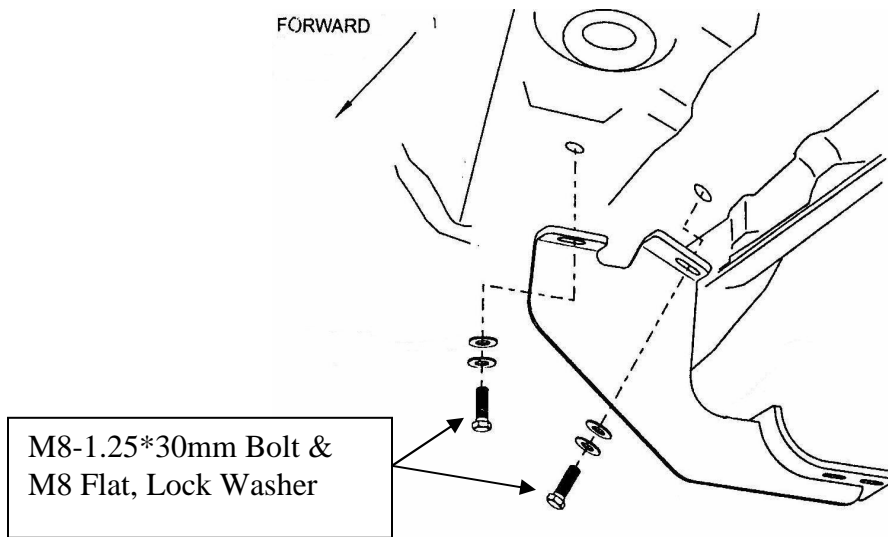

Figure 1. Passenger Side – Front Bracket

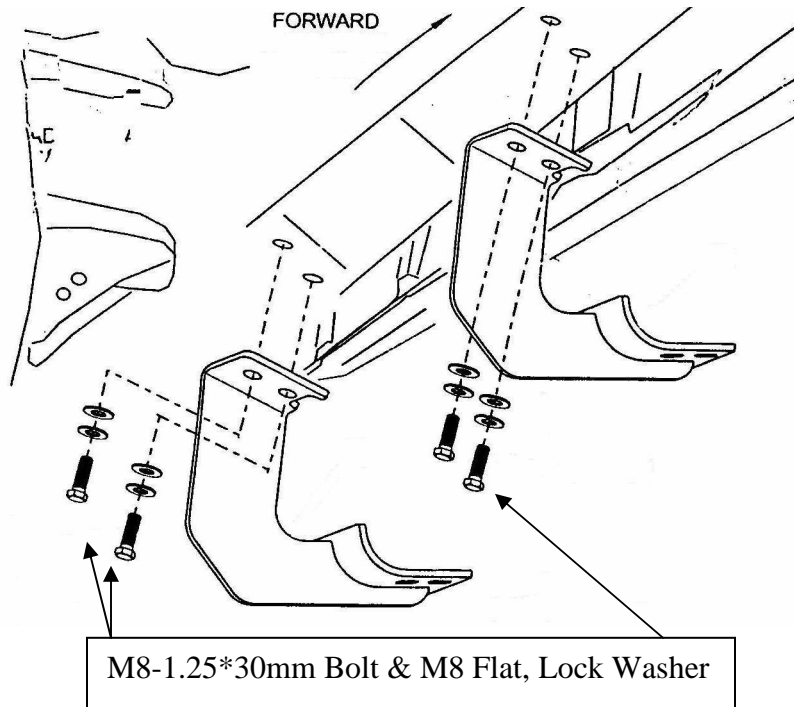

Figure 2. Passenger Side –Center & Rear Bracket

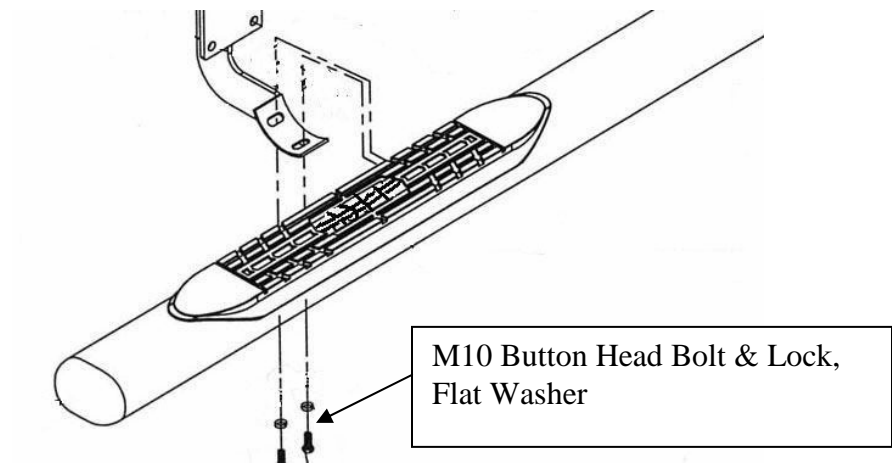

Figure 3. Installation View of Bracket & Bar