

0705-0204

2006-10 Honda Ridgeline

Components List:

- 2 – Stainless steel oval step bars
- 2 – Front/Center brackets – Driver Side
- 1 – Rear bracket – Driver Side
- 2 – Front/Center brackets – Passenger Side
- 1 – Rear bracket – Passenger Side

Parts List:

- 20 – M8-1.25 x 30 mm hex head bolts
- 20 – M8 flat washers
- 20 – M8 lock washers
- 20 – M8-1.25 Flange Nut
- 12 – M10 button head bolt
- 12 – M10 lock washers
- 12 – M10 flat washers

Installation Instruction:

1. Remove contents from box and check for damage. Verify all the parts from the list above are present and accounted for. Please read instructions completely before starting.
2. Determine passenger and driver brackets. Both front and center brackets are the same for each side. The metal cup on each bracket should hang over towards the rear of vehicle (**see Fig 1**)
3. Install driver side front and center brackets as shown (**see Fig 1**). Attach to existing holes in rocker panel under the vehicle using 4 M8-1.25 x 30mm hex head bolts and washers per bracket. Hand tighten.
4. Install driver side rear bracket using existing holes in rocker panel under the vehicle using 2 M8-1.25 x 30mm hex head bolts and washers per bracket. Hand tighten (**see Fig 2**).
5. Place driver side step bar on brackets. Each step bar is marked driver and passenger.
6. Assemble with M10 button head bolts and M10 washers. 2 bolts per bracket, 6 bolts per bar (**see Fig 3**). Hand tighten.
7. Repeat installation for passenger side.

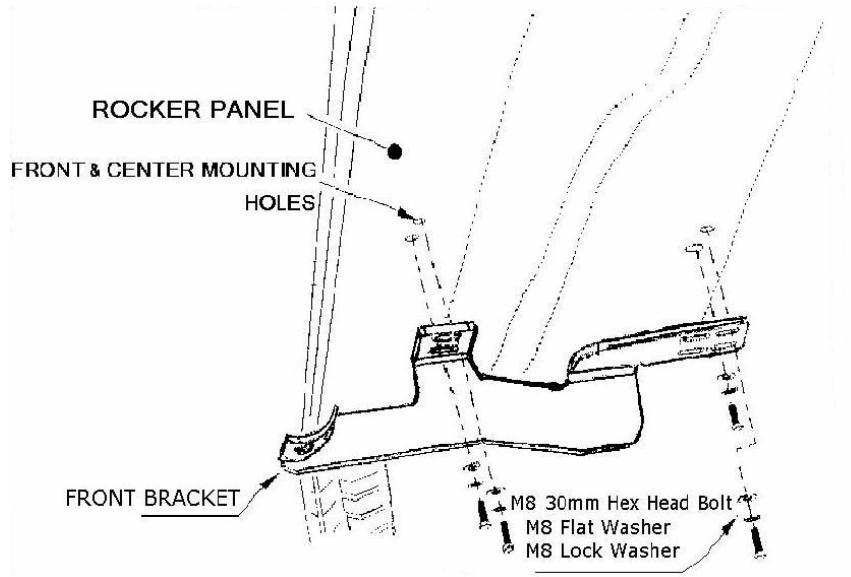

Figure 1. Installation View of Front Driver Side Shown

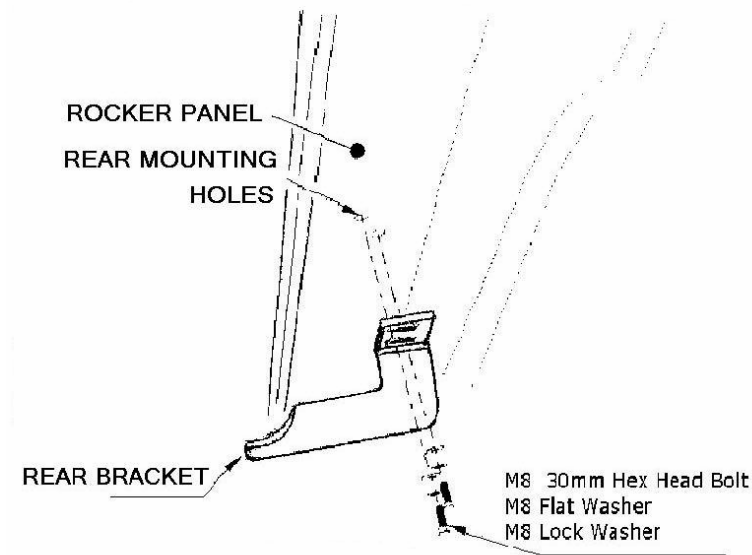

Figure 2. Installation View of Rear Driver Side Shown

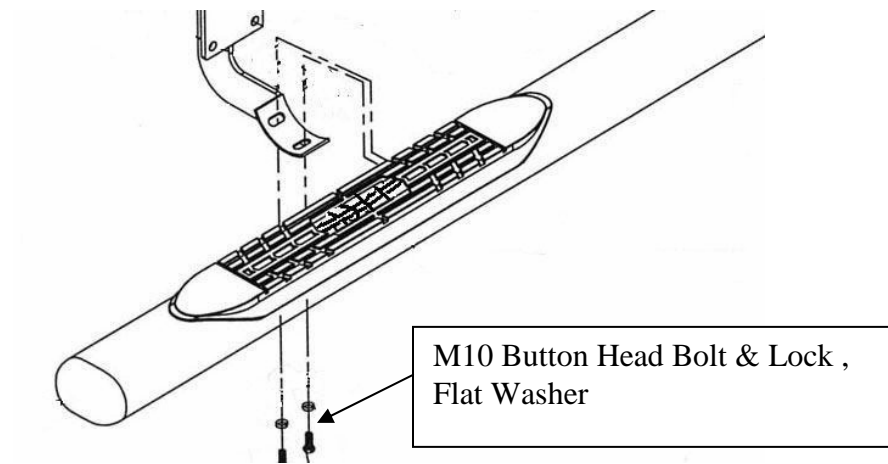

Figure 3. Installation Passenger View of Bracket & Bar