

0802-0101

2002-10 Dodge Ram 1500/2500/3500 Regular Cab

Components List:

- 2 – Stainless steel oval step bars
- 2 – Front Bracket – Driver & Passenger Side
- 2 – Rear Bracket – Driver & Passenger Side
- 2 – Front Support Brace – Driver & Passenger Side
- 2 – Bolt Plate

Parts List:

- 2 – M10-1.25 x 30mm Hex Head Bolts
- 6 – M10 Flat Washers
- 4 – M10 Lock Washers
- 4 – M10 Hex Nut
- 2 – Plastic Washer (Square)
- 4 – M12-1.75 x 120mm Hex Bolt
- 4 – M12 Flat Washer
- 4 – Rubber Washer
- 8 – M10 button head bolt
- 8 – M10 lock washers
- 8 – M10 Flat washers

Installation Instructions:

1. Remove contents from box and check for damage. Verify all the parts from the list above are present and accounted for. Please read instructions completely before starting.
2. **(2009 & UP New Body Style Ram 1500 Rear Body Mount Bracket installation. See page 3 & 4).** Note: Place rubber washers between bushing and bracket to prevent squeaking.
3. 2002-2008 Ram 1500 Rear Body Mount Bracket installation: Remove existing body mount bolts as shown (see Fig. 1 and Fig. 2).
4. Install front and rear passenger brackets as shown using M12-1.75 x 120mm Hex Bolt or existing body mount bolt (see Fig 1 and Fig. 2).
5. Attach plastic washer to bolt plate. Insert bolt plate into hole on inside wall of rocker panel (see Fig. 1). Connect support brace to bolt plate and main front bracket. Hand tighten.
6. Place passenger side step bar on brackets. Each step bar is marked driver and passenger.
7. Assemble with M10 button head bolts and M10 washers. 2 bolts per bracket, 4 bolts per bar (see Fig 3). Hand tighten.
8. Repeat installation for driver side.

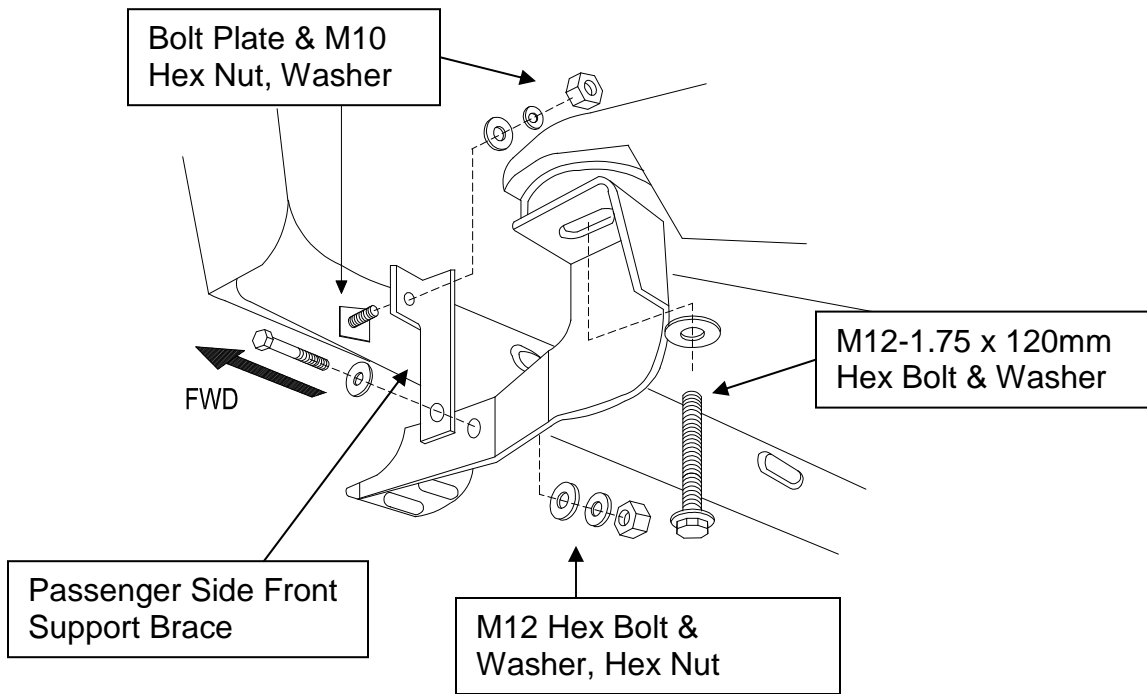

Figure 1. Passenger Side – Front Bracket

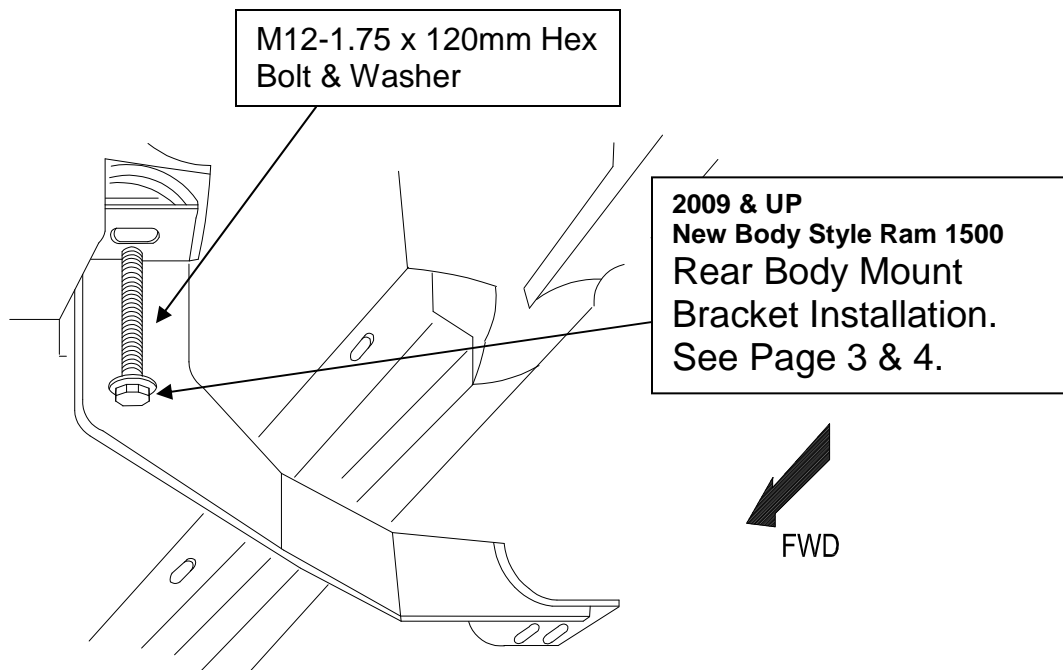

Figure 2. Passenger Side – Rear Bracket

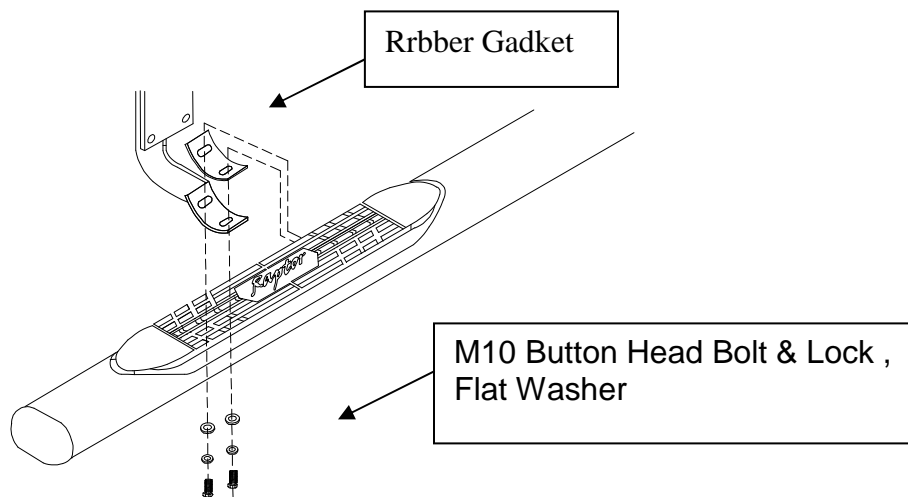

Figure 3. Installation View of Bracket & Bar

2009 & Up New Body Style Dodge Ram 1500

Rear Body Mount Bracket Installation

1. The rear body mount on this vehicle has a metal bushing (see picture #4 in original position before install).



picture #4

2. In order to attach rear bracket to mount, this metal bushing needs to be turned over upside down to let 120mm bolt provided in the kit fully screw in the threaded hole. You must take out the original body mount bolt first and use the 120mm provided in its place.

3. Insert the 120mm bolt through the bracket and through the metal bushing upside down before installing back to body mount connection (see picture #5 showing 120mm bolt through bracket and upside down metal bushing).

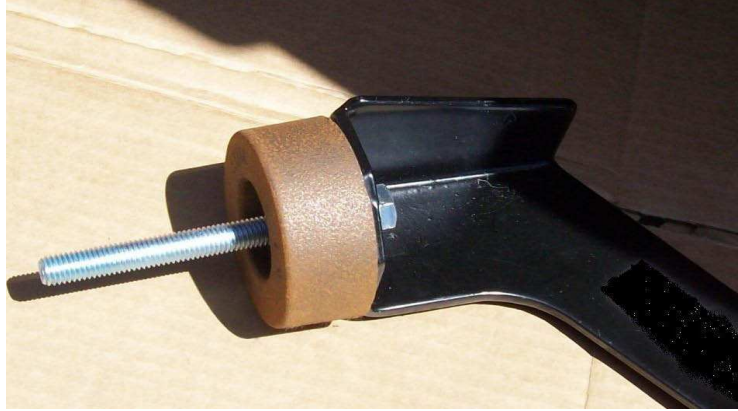

picture #5

4. Please leave the bracket loose so you can attach the support brace to the main bracket. After installation, it should look like this (see picture #6 showing the bracket after install).



picture #6